

FILED FOR RECORD: 3-14-
DULY RECORDED: 3-15-
INSTRUMENT NO. _____

1983 at 9:00 o'clock A M
1983 at 9:00 o'clock A M
GRACE BOSTICK, TYLER CO. CLK.
Grace Bostick

TYLER COUNTY COMMISSIONER'S COURT
SPECIAL MEETING
MARCH 4, 1983

VOL 007 PAGE 804

A Special Meeting of the Commissioner's Court, met on Friday March 4, 1983 at 10:00 A.M. All members being present. The meeting was opened with prayer by County Judge Allen Sturrock.

A motion was made by Commissioner Riley and seconded by Commissioner Lowe to accept the Bid of Oil City Tractors, Inc., on a used Backhoe for Precinct 1. The amount being \$10,464.00. one half of the amount to pay from R.B. Pct. #1, on the down payment, and the balance on Time Warrants, for one year. All voted yes and none no. See Bids attached.

A motion was made by Commissioner Riley and seconded by Commissioner Lowe to extend the time on bidding for County Hospitalization Insurance, until April 11, 1983. American National Insurance will be requested to release the County's experience rating on insurance for the last two years, to all bidding firms. All voted yes and none no.

A motion was made by Commissioner Lowe and seconded by Commissioner Odom to accept the Bid of The Furniture Center, on an Air Conditioner for the County Clerks Office. The amount of the cost being \$527.04. All voted yes and none no. See bids attached.

There being no further business, the meeting adjourned.

SIGNED: Allen Sturrock Allen Sturrock, County Judge

Maxie Riley Maxie Riley, Comm. Pct. #1

H.K. Lowe H.K. Lowe, Comm. Pct. #2

Jerry Mahan Jerry Mahan, Comm. Pct. #3

Berton Adnell Odom Berton Adnell Odom, Comm. Pct. #4

ATTEST: Grace Bostick Grace Bostick County Clerk

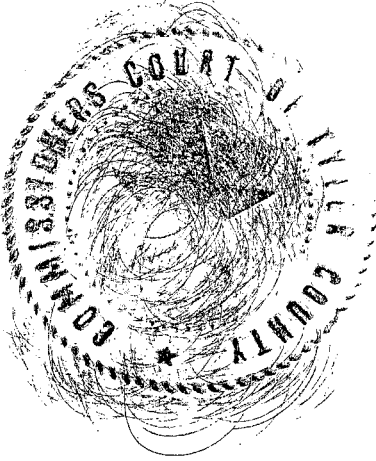



OIL CITY TRACTORS, INC.

FARM — INDUSTRIAL
EQUIPMENT

3900 SOUTH 11TH STREET PHONE 842-3666 MID-COUNTY 735-5828
P. O. BOX 710 BEAUMONT, TEXAS 77704

February 28, 1983

Tyler County
100 Courthouse
County Clerk
Woodville, Texas 75979

VOL 007 PAGE 805

Attention Mrs. Grace Bostick

Gentlemen:

In accordance with your request we are pleased to quote you prices on the following equipment:

One Used Ford Model 4500 Tractor, Loader, Backhoe with the following specifications:

General: Power assist steering, differential lock, foot throttle, heavy duty industrial front axle, 4 post roll over protective system with seat belt.

Engine: Diesel 3 cylinder
201 Cu. In. displacement
59 H.P. at 2200 R.P.M.
12 volt electrical system
Dry type air cleaner

Hydraulics: Pump Capacity 23 GPM @ 2200 R.P.M.

Loader: 1 Yd. tread width front bucket
4500 lb. lift capacity

Backhoe: 24" bucket
Digging depth 15 ft.

Warranty: 90 days engine, transmission & clutch

Above unit has 2 new front tires and is serviced out ready for operation.

Price, F. O. B. Tyler County, Woodville, Texas \$ 10,464.00

We appreciate the opportunity of furnishing you this quotation. Should you require additional information, please contact us.

Sincerely yours,

OIL CITY TRACTORS, INC.

Dennis Crawford
Sales Department

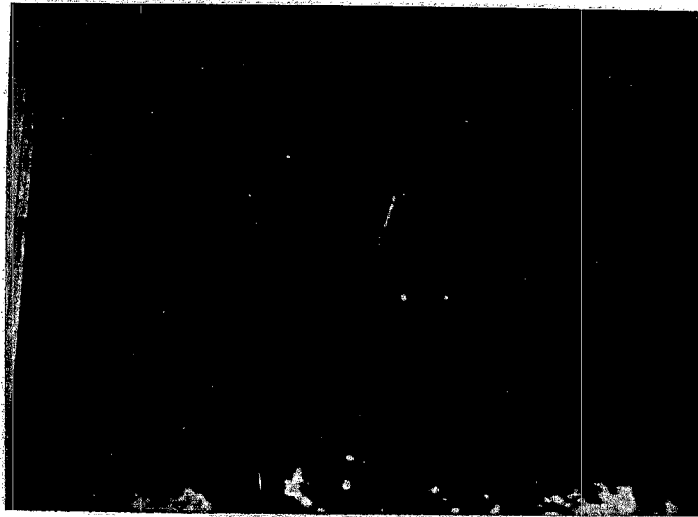

FARMERS SUPPLY

CAREL RASBERRY, Owner

327-8171

HWY. 59 SOUTH

327-8118

DRAWER 270

LIVINGSTON, TEXAS 77351

VOL 007 PAGE 807

SALES AND SERVICE



BOLENS



TRACTOR AND EQUIPMENT RENTAL

Livingston, Texas
March 3, 1983

Commissioners Court
100 County Court House
Woodville, Texas

Dear Sir:

I would like to submit the following bid quotation on the following machinery.

- 1 (One) Used Case 580-B Backhoe and Loader, Ser, #8739481
with full power shift transmission
with torque converter
207 cu." Diesel engine
with lights
with power steering
7/8 cu. yd. loader bucket
with self leveling
14.5 ft. backhoe with 24" bucket
New Case paint and decals
11 - L X 16 10 ply front tires - Goodyear
17.5 L X 24 8 ply rear tires - Goodyear
Completely serviced

This machine will carry a 90 day mechanical warranty.

We can make immediate delivery.

For selling price of: \$13,000.00

Sincerely,
Carel Rasberry
Carel Rasberry
Farmers Supply
Livingston, Texas

77351



500C BACKHOE LOADER

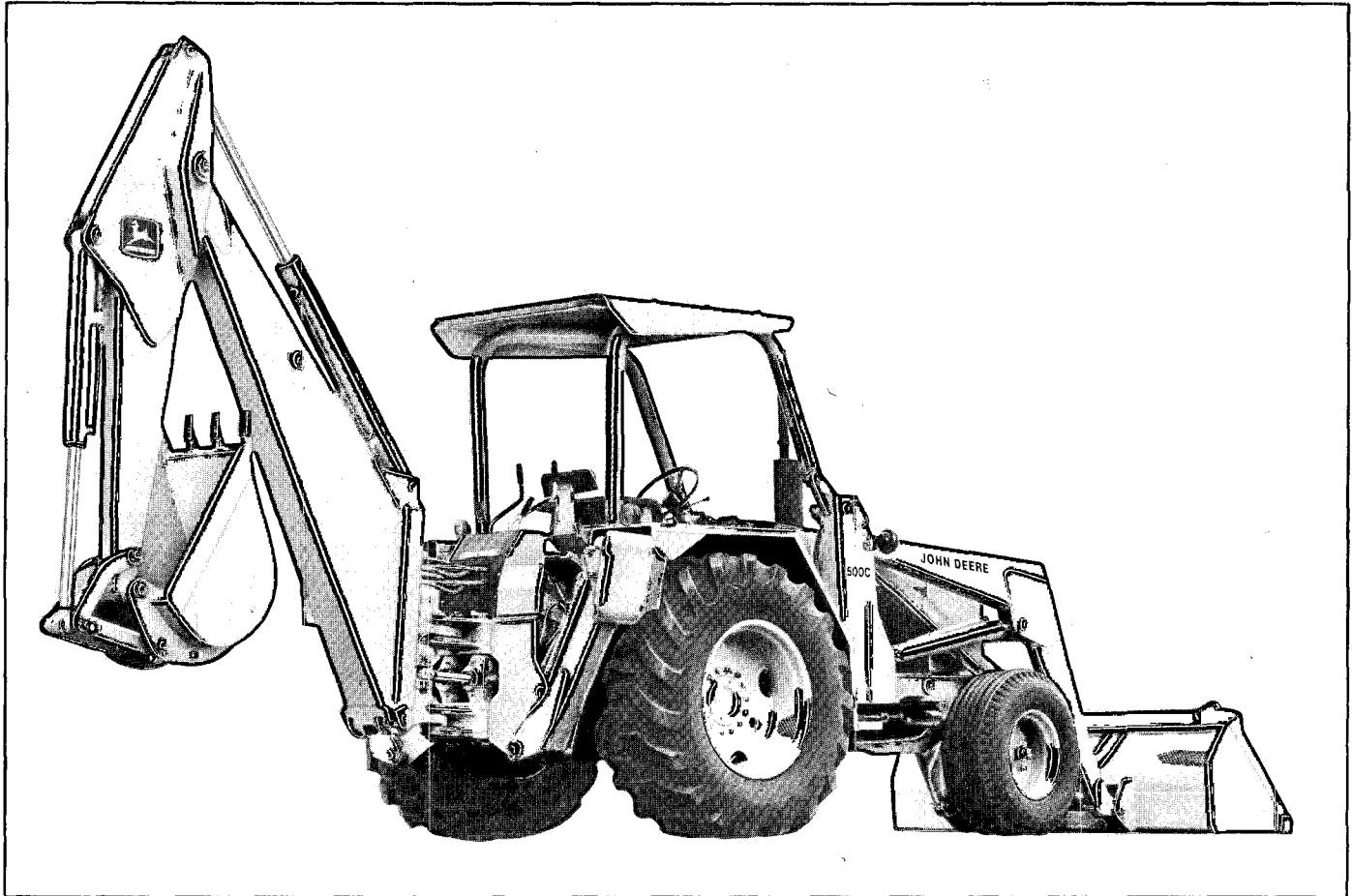

ENGINE PERFORMANCE

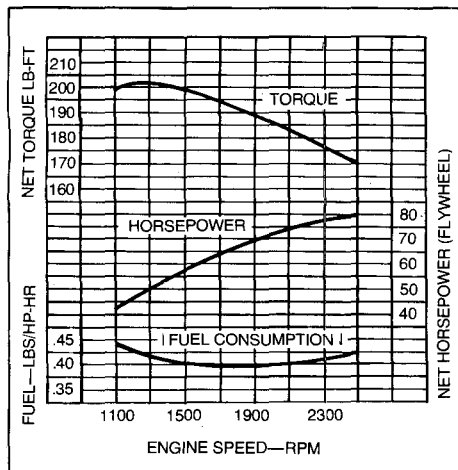

FEATURES

- 80 SAE net hp (59.7 kW)
- Backhoe digging depth (ICED) 15 ft. (4.57 m)
- Power shift transmission
- Self-adjusting wet-disk power brakes
- Inboard planetary final drives
- Roll-over protective structure (ROPS)
- Choice of 2 self-leveling loader buckets
- Single-lever loader control
- Single, swing-around seat
- Two-lever backhoe control
- Choice of 10 backhoe buckets
- Extendable dipperstick available
- Power Steering

500C BACKHOE LOADER SPECIFICATIONS

(Specifications and design subject to change without notice. Wherever applicable, specifications are in accordance with ICED and SAE Standards. Except where otherwise noted, these specifications are based on a unit equipped with 18.4-28, 8-ply-rating rear tires; 14.5/75-16, 10-ply-rating front tires; 1 cu. yd. (0.76 m³) loader bucket, 24 in. (610 mm) standard backhoe bucket and standard equipment.)

Power (@ 2500 engine rpm):	SAE	DIN
Gross	83 hp (61.9 kW)	
Net	80 hp (59.7 kW)	85.0 PS

Net engine flywheel power is for an engine equipped with fan, air cleaner, water pump, lubricating oil pump, fuel pump, alternator, and muffler. Gross engine power is without fan. Flywheel power ratings are under SAE standard conditions of 500-ft. altitude and 85°F. temperature and DIN 70 020 standard conditions of 760 mm Hg barometer (sea level) and 20°C temperature.

Engine: John Deere diesel, 4-cylinder, 4-stroke cycle	
Bore and stroke	4.25×4.75 in. (108×121 mm)
Piston displacement	270 cu. in. (4.425 L)
Compression ratio	17.3 to 1
Maximum torque @ 1300 rpm	202 lb-ft (274 Nm) (27.9 kg-m)
NACC or AMA (U.S. Tax) horsepower	28.9
Main bearings	5
Lubrication	Pressure system w/full-flow filter
Cooling	Pressurized w/thermostat and fixed bypass
Fan	Suction
Air cleaner w/restriction indicator	Dry
Electrical system	12-volt w/alternator
Batteries (two 6 volt)	Reserve capacity: 340 minutes each

Transmission:

Full power shift, 8 speeds forward, 4 reverse. Power shift from forward to reverse in first 4 gears.

Gear:	Travel Speeds	
	mph	km/h
Forward 1	1.7	2.7
2	2.4	3.9
3	3.8	6.1
4	4.9	7.9
5	6.3	10.1
6	8.1	13.0
7	10.8	17.4
8	18.0	29.0
Reverse 1	2.0	3.2
2	2.8	4.5
3	4.4	7.1
4	5.7	9.2

Final Drives Inboard, planetary

Brakes Hydraulically power actuated, fully enclosed wet-disk. Self-equalizing. Foot-operated individually or simultaneously.

Steering: Power

Turning radius (brake applied)	11 ft. 2 in. (3.40 m)
Loader clearance (brake applied)	33 ft. (10.06 m)
Number of turns, far left to far right	5

Hydraulic System: Closed-center

Pressure	2350 psi (16 203 kPa) (165.2 kg/cm ²)
Loader control	Single-lever
Backhoe control	Two-lever
Pump	Piston, constant pressure, variable-displacement
38 gpm (2.4 L/s) @ 2500 engine rpm	
Filter	25-micron steel-enclosed paper cartridge in return

Hydraulic Cylinders:	Bore	Stroke
Loader boom	3.25 in. (83 mm)	28.7 in. (729 mm)
Loader bucket	3.25 in. (83 mm)	16.7 in. (424 mm)
Backhoe boom	4.5 in. (114 mm)	36.7 in. (932 mm)
Backhoe crowd	4.5 in. (114 mm)	35.5 in. (902 mm)
Backhoe bucket	3.5 in. (89 mm)	27.37 in. (695 mm)
Backhoe swing	4 in. (102 mm)	9.31 in. (237 mm)
Stabilizer	3.5 in. (89 mm)	16.9 in. (429 mm)

Cylinder rods	Ground, heat-treated, chrome-plated, polished
Loader boom, backhoe swing and stabilizer cylinder rods	1.75-in. (44 mm) dia.
Loader bucket cylinder rods	1.50-in. (38 mm) dia.
Backhoe crowd, boom and bucket cylinder rods	2.25-in. (57 mm) dia.

Tires:	Front	Rear
	14.5/75-16.1, 10-ply-rating, F3	18.4-28, 8-ply-rating, R4
		18.4-28, 12-ply-rating, R4

Wheel Treads:

Front	66 in. (1.68 m)
Rear	65.5 in. (1.66 m)

Capacities:	U.S.	Imp.	Liters
Cooling system	4.75 gal.	4.0 gal.	18.0
Fuel tank	34 gal.	28.3 gal.	128.7
Engine lubrication, including filter	8 qt.	6.7 qt.	7.6
Transmission and hydraulic system	21.5 gal.	18.0 gal.	81.4

OPERATING INFORMATION

LOADER:

Rollback at ground level	40 deg.
Breakout force	7800 lb. (34.96 kN) (3538 kg)
Digging depth below ground level (with bucket level)	1 in. (25 mm)
Lifting capacity, full height	5300 lb. (2404 kg)
Height to bucket hinge pin	10 ft. 9 in. (3.28 m)
Maximum dump angle	60 deg.
Clearance, bucket dumped at 45 degrees	8 ft. 6 in. (2.59 m)
Reach at maximum height, bucket dumped at 45 degrees	2 ft. 10 in. (864 mm)
Raising time to full height	4.5 sec.
Bucket dump time	1.5 sec.
Lowering time (power)	3.0 sec.

BACKHOE:

Digging depth (ICED):	
Maximum	15 ft. 1 in. (4.60 m)
2-ft. (610 mm) flat bottom	15 ft. (4.57 m)
8-ft. (2.44 m) flat bottom	14 ft. (4.27 m)
Swing arc	180 deg.
Lifting capacity:	
Boom at full reach and full height	1950 lb. (884 kg)
Dipper lifting, boom holding, full height	3300 lb. (1497 kg)
Digging force (bucket cylinder in power-dig position)	9650 lb. (43.25 kN) (4377 kg)
Digging force, crowd cylinder	7158 lb. (32.08 kN) (3247 kg)
Reach from center of swing mast	18 ft. 7 in. (5.66 m)
Reach from center of rear axle	22 ft. 1 in. (6.73 m)
Loading height (truck-loading position)	11 ft. 8 in. (3.56 m)
Transport height	11 ft. 8 in. (3.56 m)
Bucket rotation	Adjustable for 123, 126, or 154 deg.
Bucket position	Adjustable for 22 or 13 deg. rollback and 2 deg. forward

Stabilizer Width:

Transport position	7 ft. 3 in. (2.21 m)
Operating position (overall)	10 ft. 2 in. (3.10 m)
Operating position (ICED)	8 ft. 9 in. (2.67 m)

Buckets:

LOADER	Nominal Heaped Capacity	Width
General Purpose	1 cu. yd. (0.76 m ³)	89.4 in. (2.27 m)
Light Materials	1¼ cu. yd. (0.96 m ³)	89.4 in. (2.27 m)
BACKHOE	Struck Capacity	Width
Standard	2.5 cu. ft. (0.071 m ³)	12 in. (305 mm)
	3.6 cu. ft. (0.102 m ³)	16 in. (406 mm)
	4.4 cu. ft. (0.125 m ³)	18 in. (457 mm)
	6.0 cu. ft. (0.170 m ³)	24 in. (610 mm)
	7.6 cu. ft. (0.215 m ³)	30 in. (762 mm)
	7.2 cu. ft. (0.204 m ³)	36 in. (914 mm)
Heavy-duty	4.4 cu. ft. (0.125 m ³)	18 in. (457 mm)
	6.0 cu. ft. (0.170 m ³)	24 in. (610 mm)
	7.6 cu. ft. (0.215 m ³)	30 in. (762 mm)
Ejector	4.2 cu. ft. (0.119 m ³)	24 in. (610 mm)

500C BACKHOE LOADER DIMENSIONS

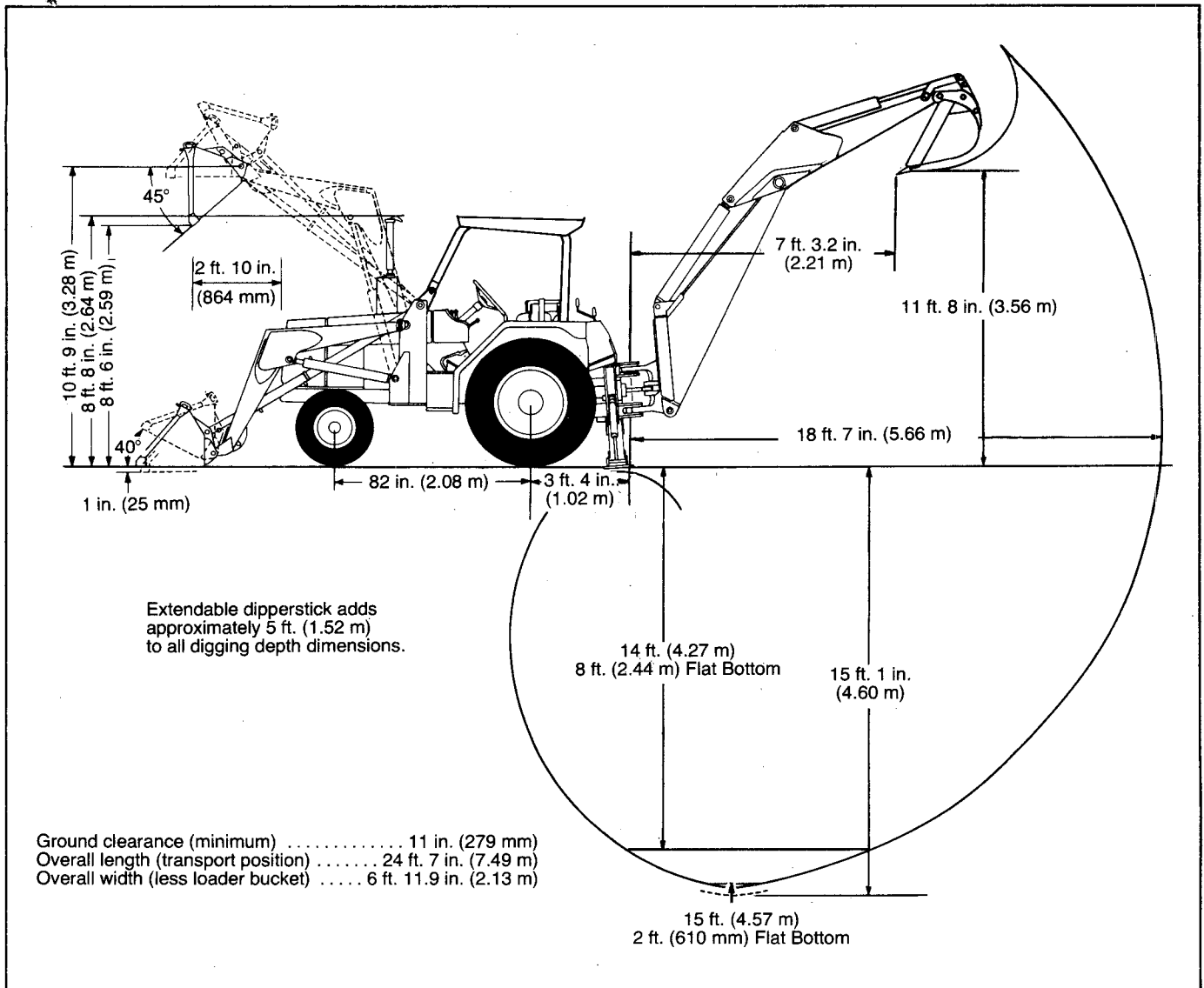

Additional Standard Equipment:

- Differential lock
- Vertical muffler w/rain cap
- Fuel gauge
- Oil pressure indicator light
- Alternator charge indicator light
- Water temperature gauge
- Trans. lube pressure indicator light
- Flat deck w/skid-proof platform
- Rear reflector
- Transistorized voltage regulator
- Key switch w/push-button safety start
- Lights

Special Equipment:

- Ether starting aid
- Fenders
- Horn
- Bucket level indicator
- Electric hourmeter
- Foot throttle
- Cigaret lighter
- Trans. temp. gauge
- Tachometer
- Hand throttle
- Antifreeze
- Deluxe swing-around seat
- Vandal protection
- ROPS w/canopy and seat belt

Special Equipment:

- Exhaust extension
- Steel bucket teeth for loader
- Cab (includes ROPS, front windshield wiper, seat belt and exhaust extension)
- Cab pressurizer
- Cab heater
- Cab defroster
- 24 in. (610 mm) ripper tooth for backhoe
- Bolt-on stabilizer street pads
- Extendable dipperstick
- Parking brake
- Reversible stabilizer pads
- Backup alarm

SAE Operating Weight 16,063 lb. (7286 kg)



Allen Machinery Company, Inc.

P.O. Box 3327 - Loop 287 West
Lufkin, Texas 75901
Phone 713-634-8801

VOL 007 PAGE 809

2 March 1983

Commissioners Court
Tyler County
Woodville, Texas 75979

Subject: Backhoe for Precinct 1

Gentlemen:

We are pleased to quote on a John Deere 500-C Loader Backhoe as follows:

1 - Used JD 500-C Loader Backhoe (1973)

Digging Depth: 15' 1"

80 Net H.P. Diesel Engine

1 Yard Loader Bucket

Lifting Capacity 5300 Pounds

24" Backhoe Bucket

12 Volt Electrical System

Heavy Duty Industrial Front End

38 GPM Hydraulic System at 2500 RPM

ROPS

Delivery: One Day

Warranty: Three Months Warranty on Engine, Transmission, and Clutch

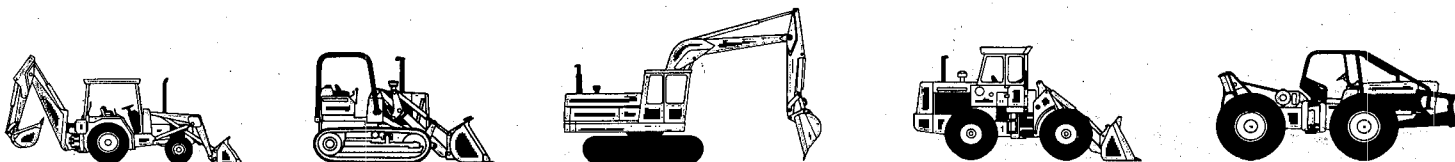



Allen Machinery Company, Inc.

P.O. Box 3327 - Loop 287 West
Lufkin, Texas 75901
Phone 713-634-8801

VOL 007 PAGE 810

Continued - Page 2

Net Price FOB Job Site

\$13,900.00

Thank you for allowing Allen Machinery to help you with your equipment needs. If we can be of any further assistance, please do not hesitate to call.

Very truly yours,

Glen McDaniel

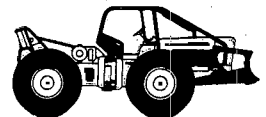
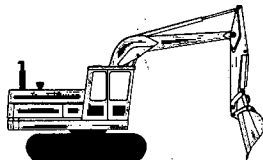
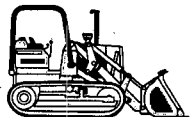
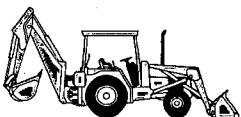

THE FURNITURE CENTER

107 EAST BLUFF

WOODVILLE, TEXAS 75979

VOL 007 PAGE 812

Mrs. Bastick - We can furnish the courthouse with a
12,000 BTU (one ton) heat and cool window unit. This
unit will be a Gibson Air Sweep and is 26" wide
with a height of 16 $\frac{1}{4}$ ". Your price will be \$527.04.

Phil McClure

MCCLURE FURNITURE COMPANY

305 N. MAGNOLIA
WOODVILLE, TEXAS 75979

VOL 007 PAGE 814

TO
Mrs. Grace Bostick

DATE
March 3, 1983
SUBJECT

Our bid for one (1) ton Emerson Quiet Kool heating and kool unit for
Tyler County Clerk's Office is -----

\$649.95

MANN Furniture CO.

206 BLUFF STREET PHONE BU 3-3740
WOODVILLE, TEXAS

March 4, 1983

VOL 007 PAGE 816

Tyler County Courthouse
Woodville, Texas 75979

Re: 14,000 BTU Whirlpool
Air Conditioner and
Heating --BID PRICE.
High Efficiency Unit
7.5 EER.

To Whom It May Concern:

I respectfully submit a bid price for the above heating and cooling unit to be installed in the Courthouse of Tyler County with no extra charge for installation under NORMAL CONDITIONS (normal installation means no extra carpenter work or electrical wiring hookup).

The bid price for a 14,000BTU heating and cooling is \$580.00. We have free Warranty Factory Service if ever needed. This product is in stock and we can install TODAY.

Thank you for your consideration.

Yours very truly,

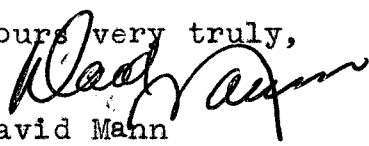
David Mann
Mann Furniture Co.

DPM:d

PHILLIPS HEATING & AIR CONDITIONING

RR 1 Box 860
 WOODVILLE, TEXAS 75979
 (713) 283-5247

VOL **007** PAGE **818**

PROPOSAL SUBMITTED TO <i>Tyler Co.</i>		PHONE	DATE <i>3/3/83</i>
STREET		JOB NAME <i>County Clerk Office</i>	
CITY, STATE AND ZIP CODE <i>Woodville, Texas</i>		JOB LOCATION	
ARCHITECT	DATE OF PLANS	JOB PHONE	

We hereby submit specifications and estimates for:

*The installation of one Carrier window unit
 model # 51BV214-3*

*14000 BTU Cooling
 10,400 BTU Heating*

Complete with all material and labor.

We Propose hereby to furnish material and labor — complete in accordance with above specifications, for the sum of:

Seven hundred & ninety _____ dollars (\$ *790.00* .)

Payment to be made as follows:

All material is guaranteed to be as specified. All work to be completed in a workmanlike manner according to standard practices. Any alteration or deviation from above specifications involving extra costs will be executed only upon written orders, and will become an extra charge over and above the estimate. All agreements contingent upon strikes, accidents or delays beyond our control. Owner to carry fire, tornado and other necessary insurance. Our workers are fully covered by Workmen's Compensation Insurance.

Authorized Signature

James R. Phillips

Note: This proposal may be withdrawn by us if not accepted within *30* days.

Acceptance of Proposal — The above prices, specifications and conditions are satisfactory and are hereby accepted. You are authorized to do the work as specified. Payment will be made as outlined above.

Date of Acceptance: _____

Signature _____

Signature _____